

Spec Sheet STP41A0800220S

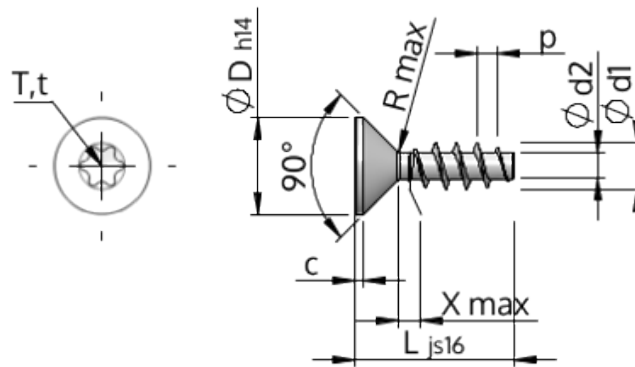

Item Number		STP41A0800220S
Standard		KN1041
Material		steel, hardened
Surface		zinc-plated 5-7 µm, baked, blue / transparent passivated
Thread Outside-Ø	<b>d1</b>	8.00 <sup>+0.22</sup> mm
Thread Core-Ø	<b>d2</b>	4.21 mm
Thread Pitch	<b>p</b>	3.59 mm
Length	<b>L</b>	22.00 ±0.65 mm
Head-Ø	<b>D</b>	15.80 <sub>-0.43</sub> mm
Cylindrical Head Height	<b>C</b>	0.95 mm
Thread Run-Out	<b>X</b>	4.00 mm
Radius	<b>R</b>	1.00 mm
Size Six Lobe		T40
Penetration Depth	<b>t</b>	2.40 - 2.90 mm
Thread		STS
Weight		7.128 kg / 1000 pieces
Customs Tariff No		73 181 499