

Spec Sheet STP41A0800200E

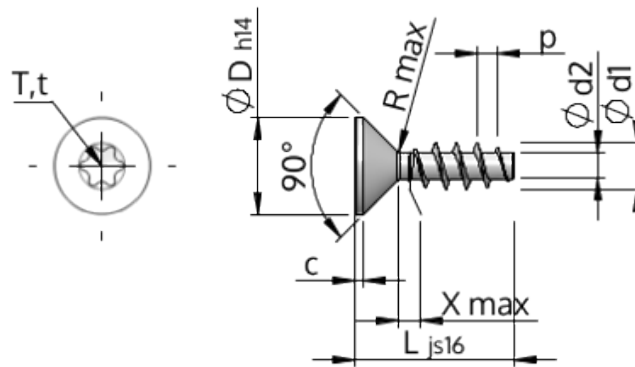

Item Number		STP41A0800200E
Standard		KN1041
Material		stainless-steel A2
Surface		bright, pickled and passivated
Thread Outside-Ø	d1	8.00 ^{+0.22} mm
Thread Core-Ø	d2	4.21 mm
Thread Pitch	p	3.59 mm
Length	L	20.00 ±0.65 mm
Head-Ø	D	15.80 _{-0.43} mm
Cylindrical Head Height	C	0.95 mm
Thread Run-Out	X	4.00 mm
Radius	R	1.00 mm
Size Six Lobe		T40
Penetration Depth	t	2.40 - 2.90 mm
Thread		STS
Weight		6.765 kg / 1000 pieces
Customs Tariff No		73 181 410