

Detalii tehnice STP41A0600350S

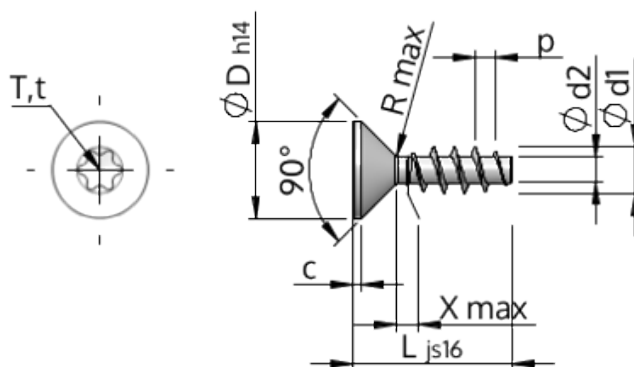

SCREWERK



Numărul articolului		STP41A0600350S
Norma		KN1041
Material		oțel, călit
Exterior		zincat 5-7 μm , repect, pasivat transparent/albastru
Diametrul exterior al filetului- \emptyset	d1	6.00 $^{+0.18}$ mm
Diametru șurub	d2	3.19 mm
Pasul filetului	p	2.69 mm
Lungimea	L	35.00 ± 0.80 mm
Diametrul capului- \emptyset	D	11.30 $_{-0.43}$ mm
Cap cilindric	C	0.85 mm
Tija	X	3.00 mm
Radius	R	0.60 mm
hexalobular		T30
Adâncimea de penetrării	t	1.75 - 2.20 mm
Fir		STS
Greutate		4.442 kg / 1000 unități
Tarifal vamal nr.		73 181 499