

Spec Sheet STP41A0500300B

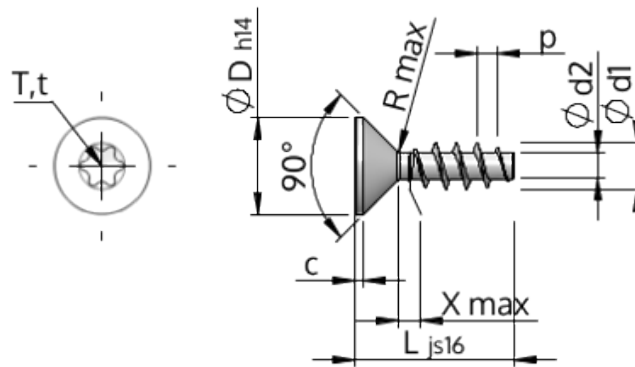

Item Number		STP41A0500300B
Standard		KN1041
Material		steel, hardened
Surface		Zinc-Nickel-plated min. 5µm, passivated black/ Cr-VI-free, baked, sealed
Thread Outside-Ø	d1	5.00 ^{+0.18} mm
Thread Core-Ø	d2	2.68 mm
Thread Pitch	p	2.24 mm
Length	L	30.00 ±0.65 mm
Head-Ø	D	9.30 _{-0.36} mm
Cylindrical Head Height	C	0.75 mm
Thread Run-Out	X	2.50 mm
Radius	R	0.45 mm
Size Six Lobe		T20
Penetration Depth	t	1.25 - 1.70 mm
Thread		STS
Weight		2.678 kg / 1000 pieces
Customs Tariff No		73 181 499