

Spec Sheet STP41A0500250S

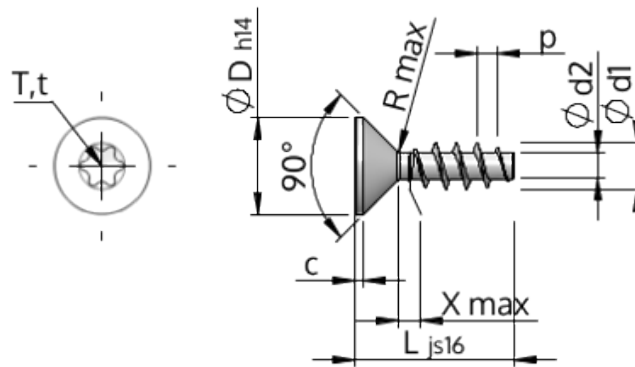

Item Number		STP41A0500250S
Standard		KN1041
Material		steel, hardened
Surface		zinc-plated 5-7 µm, baked, blue / transparent passivated
Thread Outside-Ø	<b>d1</b>	5.00 <sup>+0.18</sup> mm
Thread Core-Ø	<b>d2</b>	2.68 mm
Thread Pitch	<b>p</b>	2.24 mm
Length	<b>L</b>	25.00 ±0.65 mm
Head-Ø	<b>D</b>	9.30 <sub>-0.36</sub> mm
Cylindrical Head Height	<b>C</b>	0.75 mm
Thread Run-Out	<b>X</b>	2.50 mm
Radius	<b>R</b>	0.45 mm
Size Six Lobe		T20
Penetration Depth	<b>t</b>	1.25 - 1.70 mm
Thread		STS
Weight		2.308 kg / 1000 pieces
Customs Tariff No		73 181 499