

Spec Sheet STP41A0400110S

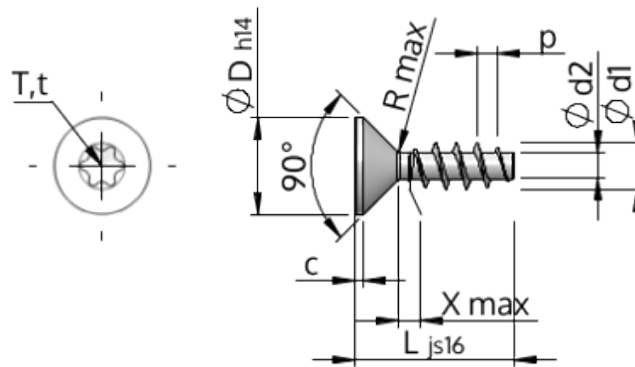

Item Number		STP41A0400110S
Standard		WN1423
Material		steel, hardened
Surface		zinc-plated 5-7 $\mu m$ , baked, blue / transparent passivated
Thread Outside- $\phi$	<b>d1</b>	4.00 $^{+0.18}$ mm
Thread Core- $\phi$	<b>d2</b>	2.17 mm
Thread Pitch	<b>p</b>	1.79 mm
Length	<b>L</b>	11.00 $\pm 0.55$ mm
Head- $\phi$	<b>D</b>	8.40 $_{-0.36}$ mm
Cylindrical Head Height	<b>C</b>	0.70 mm
Thread Run-Out	<b>X</b>	2.00 mm
Radius	<b>R</b>	0.40 mm
Size Six Lobe		T20
Penetration Depth	<b>t</b>	1.25 - 1.70 mm
Thread		STS
Weight		0.981 kg / 1000 pieces
Customs Tariff No		73 181 499