

## Detalii tehnice STP41A0350100E

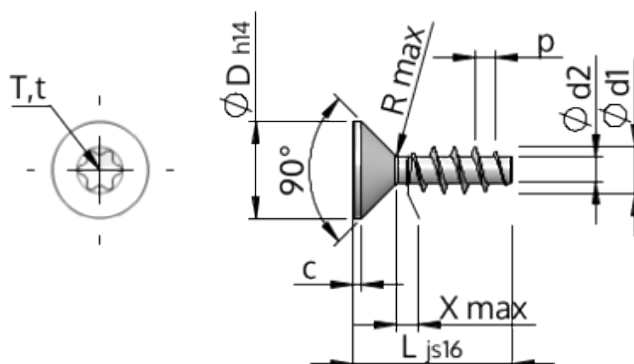

# SCREWERK



Numărul articolului		STP41A0350100E
Norma		KN1041
Material		oțel inoxidabil A2
Exterior		neacoperit, murat și pasivat
Diametrul exterior al filetului-Ø	<b>d1</b>	3.50 <sup>+0.18</sup> mm
Diametru șurub	<b>d2</b>	1.91 mm
Pasul filetului	<b>p</b>	1.57 mm
Lungimea	<b>L</b>	10.00 ±0.45 mm
Diametrul capului-Ø	<b>D</b>	7.30 <sub>-0.36</sub> mm
Cap cilindric	<b>C</b>	0.65 mm
Tija	<b>X</b>	1.80 mm
Radius	<b>R</b>	0.35 mm
hexalobular		T15
Adâncimea de penetrării	<b>t</b>	1.00 - 1.30 mm
Fir		STS
Greutate		0.645 kg / 1000 unități
Tariful vamal nr.		73 181 410