

Spec Sheet STP41A0300250E

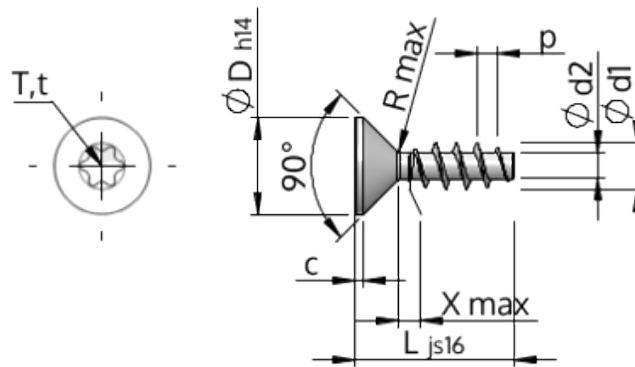

Item Number		STP41A0300250E
Standard		KN1041
Material		stainless-steel A2
Surface		bright, pickled and passivated
Thread Outside-Ø	d1	3.00 ^{+0.14} mm
Thread Core-Ø	d2	1.66 mm
Thread Pitch	p	1.34 mm
Length	L	25.00 ±0.65 mm
Head-Ø	D	5.50 _{-0.30} mm
Cylindrical Head Height	C	0.55 mm
Thread Run-Out	X	1.50 mm
Radius	R	0.35 mm
Size Six Lobe		T8
Penetration Depth	t	0.80 - 1.00 mm
Thread		STS
Weight		0.810 kg / 1000 pieces
Customs Tariff No		73 181 410