

Detalii tehnice STP41A0300120C

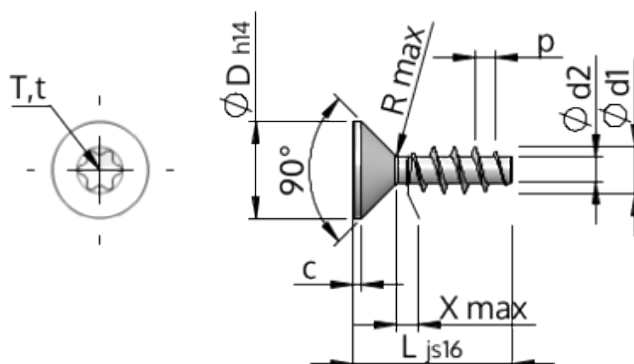

SCREWERK



Numărul articolului		STP41A0300120C
Norma		KN1041
Material		oțel inoxidabil A4
Exterior		neacoperit, murat și pasivat
Diametrul exterior al filetului-Ø	d1	3.00 ^{+0.14} mm
Diametru șurub	d2	1.66 mm
Pasul filetului	p	1.34 mm
Lungimea	L	12.00 ±0.55 mm
Diametrul capului-Ø	D	5.50 _{-0.30} mm
Cap cilindric	C	0.55 mm
Tija	X	1.50 mm
Radius	R	0.35 mm
hexalobular		T8
Adâncimea de penetrării	t	0.80 - 1.00 mm
Fir		STS
Greutate		0.437 kg / 1000 unități
Tariful vamal nr.		73 181 410