

Detalii tehnice STP41A0250160S

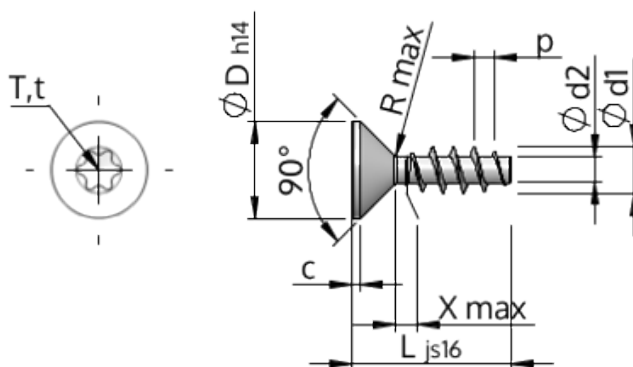

SCREWERK



Numărul articolului		STP41A0250160S
Norma		KN1041
Material		oțel, călit
Exterior		zincat 5-7 μm , repect, pasivat transparent/albastru
Diametrul exterior al filetului- \emptyset	d1	2.50 $^{+0.14}$ mm
Diametru șurub	d2	1.40 mm
Pasul filetului	p	1.12 mm
Lungimea	L	16.00 ± 0.55 mm
Diametrul capului- \emptyset	D	4.70 $_{-0.30}$ mm
Cap cilindric	C	0.55 mm
Tija	X	1.30 mm
Radius	R	0.30 mm
hexalobular		T8
Adâncimea de penetrării	t	0.70 - 0.90 mm
Fir		STS
Greutate		0.397 kg / 1000 unități
Tarifal vamal nr.		73 181 499