

Spec Sheet STP41A0250080S

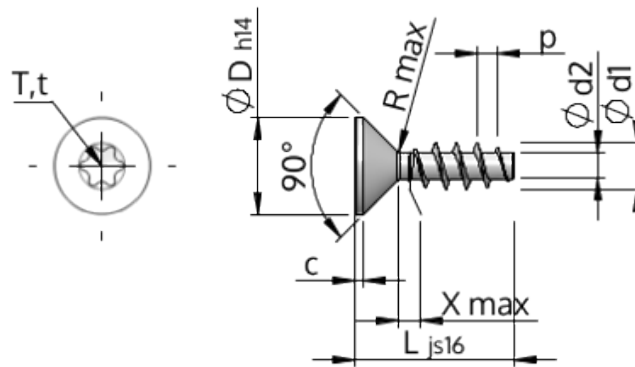

Item Number		STP41A0250080S
Standard		KN1041
Material		steel, hardened
Surface		zinc-plated 5-7 µm, baked, blue / transparent passivated
Thread Outside-Ø	d1	2.50 ^{+0.14} mm
Thread Core-Ø	d2	1.40 mm
Thread Pitch	p	1.12 mm
Length	L	8.00 ±0.45 mm
Head-Ø	D	4.70 _{-0.30} mm
Cylindrical Head Height	C	0.55 mm
Thread Run-Out	X	1.30 mm
Radius	R	0.30 mm
Size Six Lobe		T8
Penetration Depth	t	0.70 - 0.90 mm
Thread		STS
Weight		0.233 kg / 1000 pieces
Customs Tariff No		73 181 499