

Spec Sheet STP41A0220050E

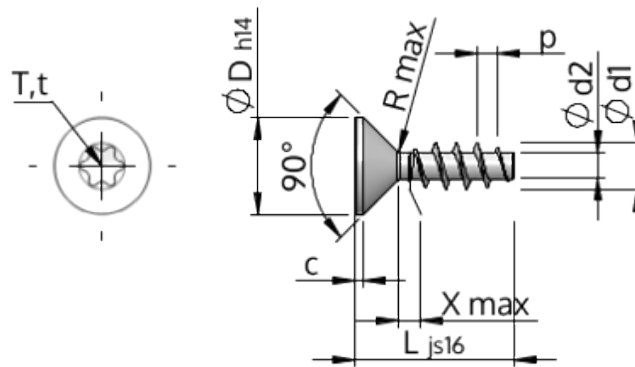

Item Number		STP41A0220050E
Standard		KN1041
Material		stainless-steel A2
Surface		bright, pickled and passivated
Thread Outside-Ø	<b>d1</b>	2.20 <sup>+0.14</sup> mm
Thread Core-Ø	<b>d2</b>	1.25 mm
Thread Pitch	<b>p</b>	0.98 mm
Length	<b>L</b>	5.00 ±0.38 mm
Head-Ø	<b>D</b>	3.80 <sub>-0.30</sub> mm
Cylindrical Head Height	<b>C</b>	0.35 mm
Thread Run-Out	<b>X</b>	1.10 mm
Radius	<b>R</b>	0.25 mm
Size Six Lobe		T6
Penetration Depth	<b>t</b>	0.65 - 0.80 mm
Thread		STS
Weight		0.119 kg / 1000 pieces
Customs Tariff No		73 181 410