

Spec Sheet STP41A0180160S

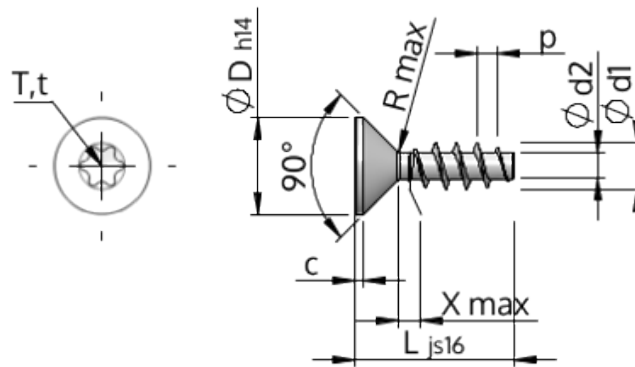

Item Number		STP41A0180160S
Standard		KN1041
Material		steel, hardened
Surface		zinc-plated 5-7 $\mu m$ , baked, blue / transparent passivated
Thread Outside- $\phi$	<b>d1</b>	1.80 $^{+0.14}$ mm
Thread Core- $\phi$	<b>d2</b>	1.04 mm
Thread Pitch	<b>p</b>	0.80 mm
Length	<b>L</b>	16.00 $\pm 0.55$ mm
Head- $\phi$	<b>D</b>	3.40 $_{-0.30}$ mm
Cylindrical Head Height	<b>C</b>	0.35 mm
Thread Run-Out	<b>X</b>	0.90 mm
Radius	<b>R</b>	0.20 mm
Size Six Lobe		T6
Penetration Depth	<b>t</b>	0.50 - 0.65 mm
Thread		STS
Weight		0.216 kg / 1000 pieces
Customs Tariff No		73 181 499