

Spec Sheet STP41A0180060B

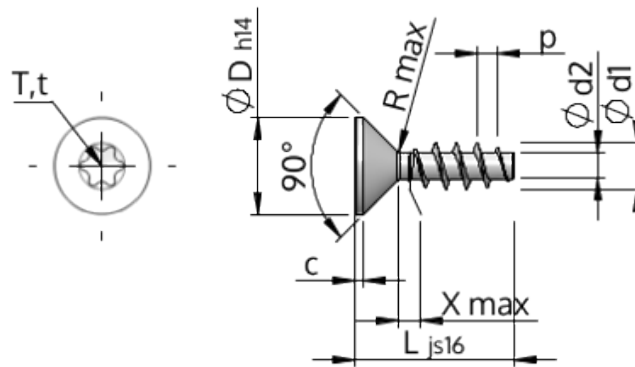

Item Number		STP41A0180060B
Standard		KN1041
Material		steel, hardened
Surface		Zinc-Nickel-plated min. 5µm, passivated black/ Cr-VI-free, baked, sealed
Thread Outside-Ø	d1	1.80 ^{+0.14} mm
Thread Core-Ø	d2	1.04 mm
Thread Pitch	p	0.80 mm
Length	L	6.00 ±0.38 mm
Head-Ø	D	3.40 _{-0.30} mm
Cylindrical Head Height	C	0.35 mm
Thread Run-Out	X	0.90 mm
Radius	R	0.20 mm
Size Six Lobe		T6
Penetration Depth	t	0.50 - 0.65 mm
Thread		STS
Weight		0.092 kg / 1000 pieces
Customs Tariff No		73 181 499