

Spec Sheet STP41A0160060S

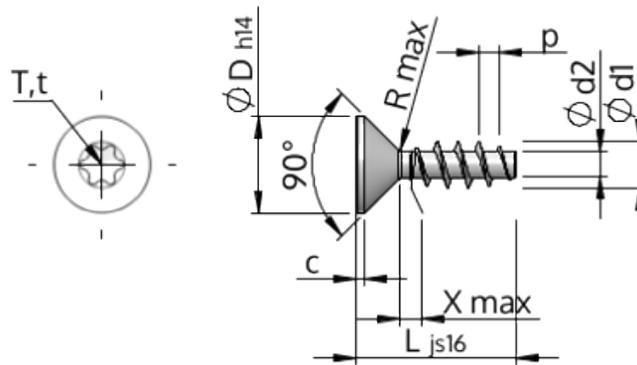

Item Number		STP41A0160060S
Standard		KN1041
Material		steel, hardened
Surface		zinc-plated 5-7 µm, baked, blue / transparent passivated
Thread Outside-Ø	<b>d1</b>	1.60 <sup>+0.14</sup> mm
Thread Core-Ø	<b>d2</b>	0.92 mm
Thread Pitch	<b>p</b>	0.67 mm
Length	<b>L</b>	6.00 ±0.38 mm
Head-Ø	<b>D</b>	3.00 <sub>-0.25</sub> mm
Cylindrical Head Height	<b>C</b>	0.35 mm
Thread Run-Out	<b>X</b>	0.80 mm
Radius	<b>R</b>	0.15 mm
Size Six Lobe		T5
Penetration Depth	<b>t</b>	0.50 - 0.65 mm
Thread		STS
Weight		0.084 kg / 1000 pieces
Customs Tariff No		73 181 499