

**Technische gegevens**  
**STP390800550S**

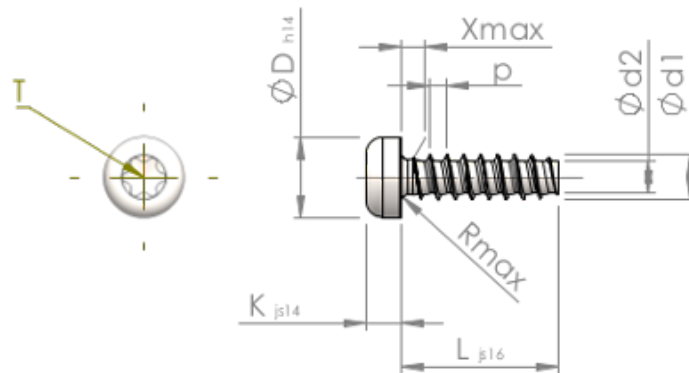

Produktnummer		STP390800550S
Norm		KN6039
Materiaal		veredeld staal
Oppervlak		verzinkt 5-7 $\mu\text{m}$ , getempert, blauw / transparant gepassiveerd
Schroefdraad buiten- $\varnothing$	<b>d1</b>	8.00 $^{+0.18}$ mm
Schroefdraad kern- $\varnothing$	<b>d2</b>	5.70 mm
Spoed	<b>p</b>	2.82 mm
Lengte	<b>L</b>	55.00 $\pm 0.95$ mm
Kop- $\varnothing$	<b>D</b>	14.10 $_{-0.43}$ mm
Kop hoogte	<b>K</b>	5.600 $\pm 0.150$ mm
Draaduitloop	<b>X</b>	4.00 mm
Radius	<b>R</b>	1.00 mm
TX		T40
Indringdiepte	<b>t</b>	2.60 - 3.20 mm
Draad		STS-plus
Gewicht		18.376 kg / 1000 stuk
Douane tarief nummer		73 181 499