

Technische gegevens
STP390800500E

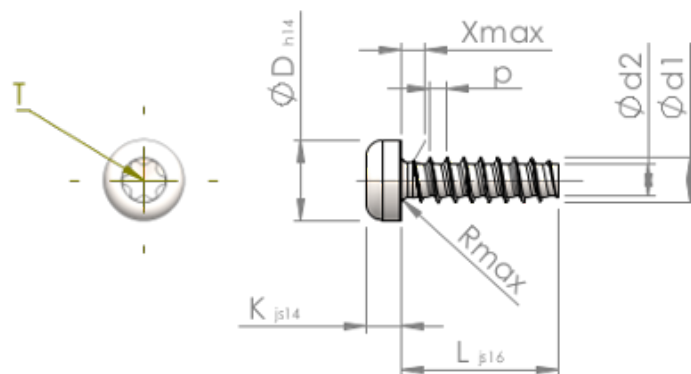

Produktnummer		STP390800500E
Norm		KN6039
Materiaal		roestvrij staal A2
Oppervlak		blank, geetst en gepassiveerd
Schroefdraad buiten- \varnothing	d1	8.00 ^{+0.18} mm
Schroefdraad kern- \varnothing	d2	5.70 mm
Spoed	p	2.82 mm
Lengte	L	50.00 \pm 0.80 mm
Kop- \varnothing	D	14.10 _{-0.43} mm
Kop hoogte	K	5.600 \pm 0.150 mm
Draaduitloop	X	4.00 mm
Radius	R	1.00 mm
TX		T40
Indringdiepte	t	2.60 - 3.20 mm
Draad		STS-plus
Gewicht		17.172 kg / 1000 stuk
Douane tarief nummer		73 181 410