

**Technische gegevens**  
**STP390700220E**

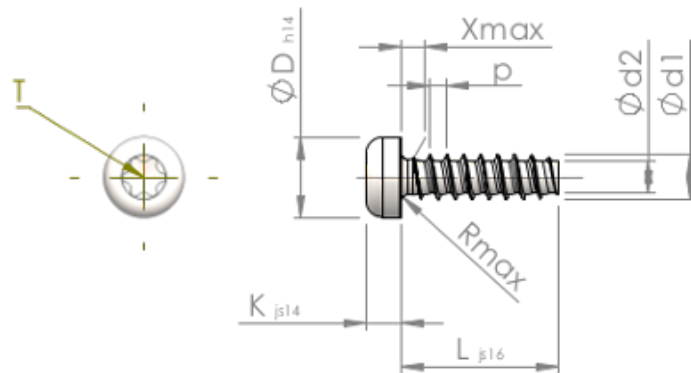

Produktnummer		STP390700220E
Norm		KN6039
Materiaal		roestvrij staal A2
Oppervlak		blank, geetst en gepassiveerd
Schroefdraad buiten- $\varnothing$	<b>d1</b>	7.00 <sup>+0.18</sup> mm
Schroefdraad kern- $\varnothing$	<b>d2</b>	4.98 mm
Spoed	<b>p</b>	2.48 mm
Lengte	<b>L</b>	22.00 $\pm$ 0.65 mm
Kop- $\varnothing$	<b>D</b>	12.30 <sub>-0.43</sub> mm
Kop hoogte	<b>K</b>	4.900 $\pm$ 0.150 mm
Draaduitloop	<b>X</b>	3.50 mm
Radius	<b>R</b>	0.90 mm
TX		T30
Indringdiepte	<b>t</b>	2.30 - 2.90 mm
Draad		STS-plus
Gewicht		7.560 kg / 1000 stuk
Douane tarief nummer		73 181 410