

Spec Sheet STP390600130B

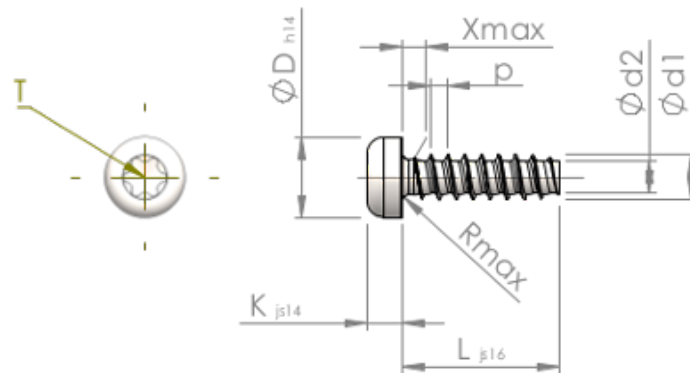

Item Number		STP390600130B
Standard		KN6039
Material		steel, hardened
Surface		Zinc-Nickel-plated min. 5µm, passivated black/ Cr-VI-free, baked, sealed
Thread Outside-Ø	d1	6.00 ^{+0.15} mm
Thread Core-Ø	d2	4.26 mm
Thread Pitch	p	2.14 mm
Length	L	13.00 ±0.55 mm
Head-Ø	D	10.50 _{-0.43} mm
Head Height	K	4.200 ±0.150 mm
Thread Run-Out	X	3.00 mm
Radius	R	0.80 mm
Size Six Lobe		T30
Penetration Depth	t	1.90 - 2.40 mm
Thread		STS-plus
Weight		3.850 kg / 1000 pieces
Customs Tariff No		73 181 499