

**Technische gegevens**  
**STP390500700E**

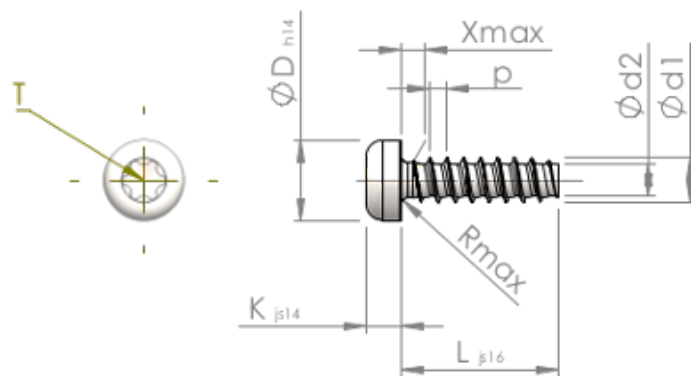

Produktnummer		STP390500700E
Norm		KN6039
Materiaal		roestvrij staal A2
Oppervlak		blank, geetst en gepassiveerd
Schroefdraad buiten- $\varnothing$	<b>d1</b>	5.00 <sup>+0.15</sup> mm
Schroefdraad kern- $\varnothing$	<b>d2</b>	3.53 mm
Spoed	<b>p</b>	1.80 mm
Lengte	<b>L</b>	70.00 $\pm$ 0.95 mm
Kop- $\varnothing$	<b>D</b>	8.80 <sub>-0.36</sub> mm
Kop hoogte	<b>K</b>	3.500 $\pm$ 0.150 mm
Draaduitloop	<b>X</b>	2.50 mm
Radius	<b>R</b>	0.70 mm
TX		T25
Indringdiepte	<b>t</b>	1.50 - 1.90 mm
Draad		STS-plus
Gewicht		7.832 kg / 1000 stuk
Douane tarief nummer		73 181 410