

Technische gegevens
STP390500400B

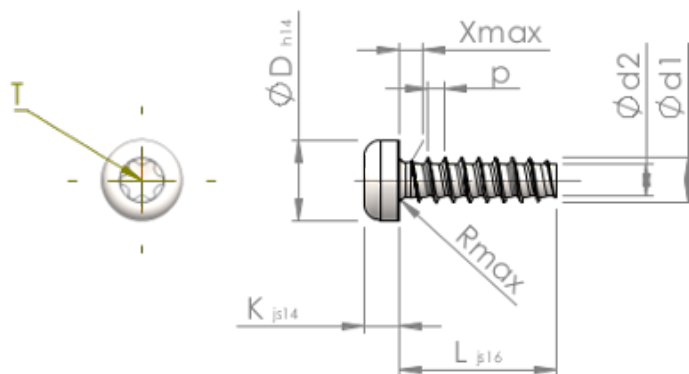

Produktnummer		STP390500400B
Norm		KN6039
Materiaal		veredeld staal
Oppervlak		ZnNi zwart-gepassiveerd, getempert, verzegeld
Schroefdraad buiten-Ø	d1	5.00 ^{+0.15} mm
Schroefdraad kern-Ø	d2	3.53 mm
Spoed	p	1.80 mm
Lengte	L	40.00 ±0.80 mm
Kop-Ø	D	8.80 _{-0.36} mm
Kop hoogte	K	3.500 ±0.150 mm
Draaduitloop	X	2.50 mm
Radius	R	0.70 mm
TX		T25
Indringdiepte	t	1.50 - 1.90 mm
Draad		STS-plus
Gewicht		4.994 kg / 1000 stuk
Douane tarief nummer		73 181 499