

Technische gegevens
STP390500380E

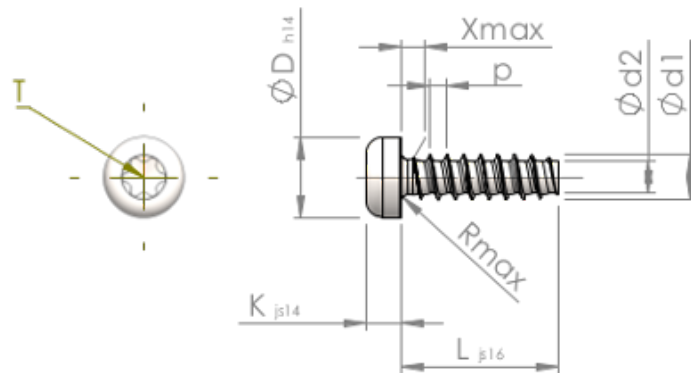

Produktnummer		STP390500380E
Norm		KN6039
Materiaal		roestvrij staal A2
Oppervlak		blank, geetst en gepassiveerd
Schroefdraad buiten- \varnothing	d1	5.00 ^{+0.15} mm
Schroefdraad kern- \varnothing	d2	3.53 mm
Spoed	p	1.80 mm
Lengte	L	38.00 \pm 0.80 mm
Kop- \varnothing	D	8.80 _{-0.36} mm
Kop hoogte	K	3.500 \pm 0.150 mm
Draaduitloop	X	2.50 mm
Radius	R	0.70 mm
TX		T25
Indringdiepte	t	1.50 - 1.90 mm
Draad		STS-plus
Gewicht		4.804 kg / 1000 stuk
Douane tarief nummer		73 181 410