

Technische gegevens
STP390450250B

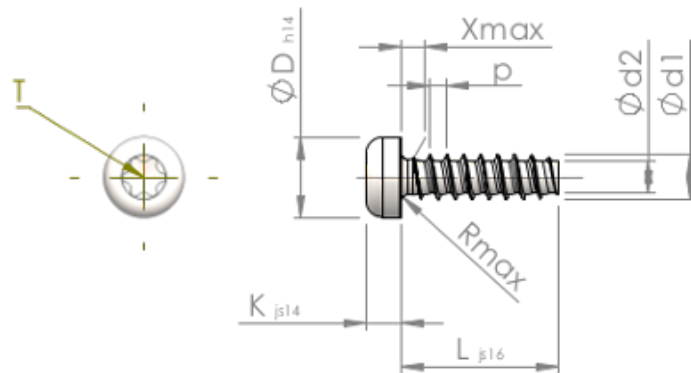

Produktnummer		STP390450250B
Norm		KN6039
Materiaal		veredeld staal
Oppervlak		ZnNi zwart-gepassiveerd, getempert, verzegeld
Schroefdraad buiten-Ø	d1	4.50 ^{+0.10} mm
Schroefdraad kern-Ø	d2	3.17 mm
Spoed	p	1.63 mm
Lengte	L	25.00 ±0.65 mm
Kop-Ø	D	7.50 _{-0.36} mm
Kop hoogte	K	3.200 ±0.150 mm
Draaduitloop	X	2.30 mm
Radius	R	0.60 mm
TX		T20
Indringdiepte	t	1.40 - 1.80 mm
Draad		STS-plus
Gewicht		2.699 kg / 1000 stuk
Douane tarief nummer		73 181 499