

Technische gegevens
STP390450220E

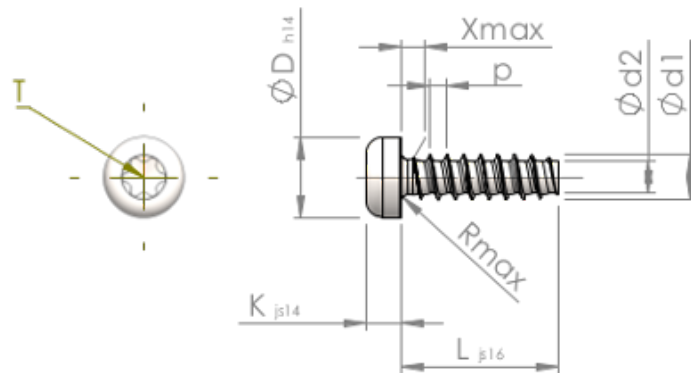

Produktnummer		STP390450220E
Norm		KN6039
Materiaal		roestvrij staal A2
Oppervlak		blank, geetst en gepassiveerd
Schroefdraad buiten- \varnothing	d1	4.50 ^{+0.10} mm
Schroefdraad kern- \varnothing	d2	3.17 mm
Spoed	p	1.63 mm
Lengte	L	22.00 \pm 0.65 mm
Kop- \varnothing	D	7.50 _{-0.36} mm
Kop hoogte	K	3.200 \pm 0.150 mm
Draaduitloop	X	2.30 mm
Radius	R	0.60 mm
TX		T20
Indringdiepte	t	1.40 - 1.80 mm
Draad		STS-plus
Gewicht		2.468 kg / 1000 stuk
Douane tarief nummer		73 181 410