

**Technische gegevens**  
**STP390400110S**

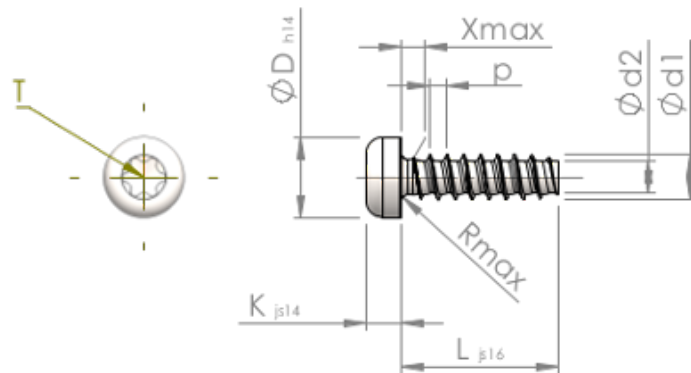

Produktnummer		STP390400110S
Norm		KN6039
Materiaal		veredeld staal
Oppervlak		verzinkt 5-7 $\mu\text{m}$ , getempert, blauw / transparant gepassiveerd
Schroefdraad buiten- $\varnothing$	<b>d1</b>	4.00 $^{+0.10}$ mm
Schroefdraad kern- $\varnothing$	<b>d2</b>	2.81 mm
Spoed	<b>p</b>	1.46 mm
Lengte	<b>L</b>	11.00 $\pm 0.55$ mm
Kop- $\varnothing$	<b>D</b>	7.00 $_{-0.36}$ mm
Kop hoogte	<b>K</b>	3.100 $\pm 0.150$ mm
Draaduitloop	<b>X</b>	2.00 mm
Radius	<b>R</b>	0.60 mm
TX		T20
Indringdiepte	<b>t</b>	1.40 - 1.80 mm
Draad		STS-plus
Gewicht		1.310 kg / 1000 stuk
Douane tarief nummer		73 181 499