

Technische gegevens
STP390400070C

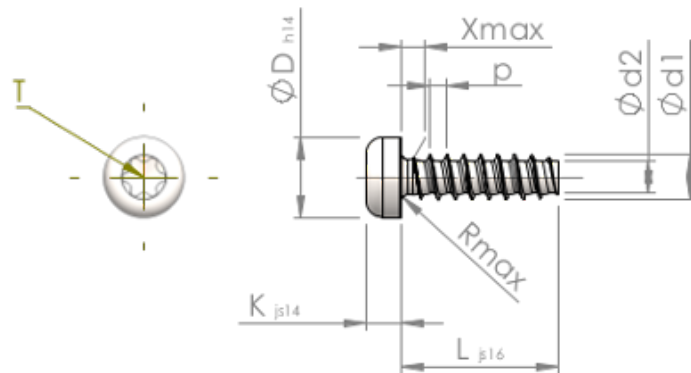

Produktnummer		STP390400070C
Norm		KN6039
Materiaal		roestvrij staal A4
Oppervlak		blank, geetst en gepassiveerd
Schroefdraad buiten- \varnothing	d1	4.00 ^{+0.10} mm
Schroefdraad kern- \varnothing	d2	2.81 mm
Spoed	p	1.46 mm
Lengte	L	7.00 \pm 0.45 mm
Kop- \varnothing	D	7.00 _{-0.36} mm
Kop hoogte	K	3.100 \pm 0.150 mm
Draaduitloop	X	2.00 mm
Radius	R	0.60 mm
TX		T20
Indringdiepte	t	1.40 - 1.80 mm
Draad		STS-plus
Gewicht		1.068 kg / 1000 stuk
Douane tarief nummer		73 181 410