

Spec Sheet STP390350140B

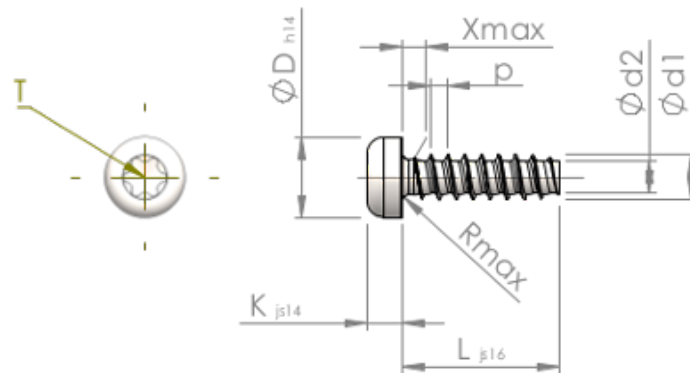

Item Number		STP390350140B
Standard		KN6039
Material		steel, hardened
Surface		Zinc-Nickel-plated min. 5µm, passivated black/ Cr-VI-free, baked, sealed
Thread Outside-Ø	d1	3.50 ^{+0.10} mm
Thread Core-Ø	d2	2.45 mm
Thread Pitch	p	1.29 mm
Length	L	14.00 ±0.55 mm
Head-Ø	D	6.10 _{-0.36} mm
Head Height	K	2.700 ±0.125 mm
Thread Run-Out	X	1.80 mm
Radius	R	0.50 mm
Size Six Lobe		T15
Penetration Depth	t	1.10 - 1.50 mm
Thread		STS-plus
Weight		1.101 kg / 1000 pieces
Customs Tariff No		73 181 499