

Spec Sheet STP390350120B

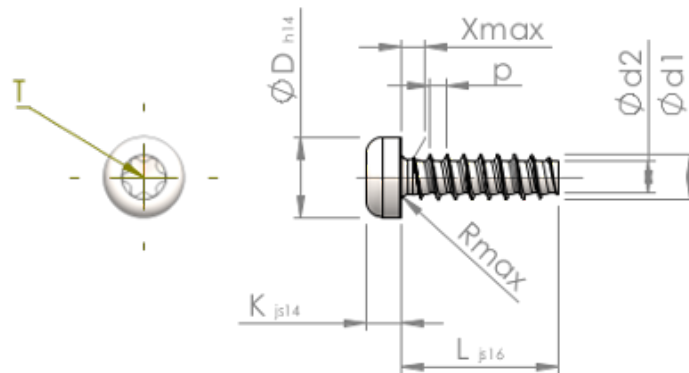

Item Number		STP390350120B
Standard		KN6039
Material		steel, hardened
Surface		Zinc-Nickel-plated min. 5µm, passivated black/ Cr-VI-free, baked, sealed
Thread Outside-Ø	<b>d1</b>	3.50 <sup>+0.10</sup> mm
Thread Core-Ø	<b>d2</b>	2.45 mm
Thread Pitch	<b>p</b>	1.29 mm
Length	<b>L</b>	12.00 ±0.55 mm
Head-Ø	<b>D</b>	6.10 <sub>-0.36</sub> mm
Head Height	<b>K</b>	2.700 ±0.125 mm
Thread Run-Out	<b>X</b>	1.80 mm
Radius	<b>R</b>	0.50 mm
Size Six Lobe		T15
Penetration Depth	<b>t</b>	1.10 - 1.50 mm
Thread		STS-plus
Weight		1.007 kg / 1000 pieces
Customs Tariff No		73 181 499