

Spec Sheet STP390300120E

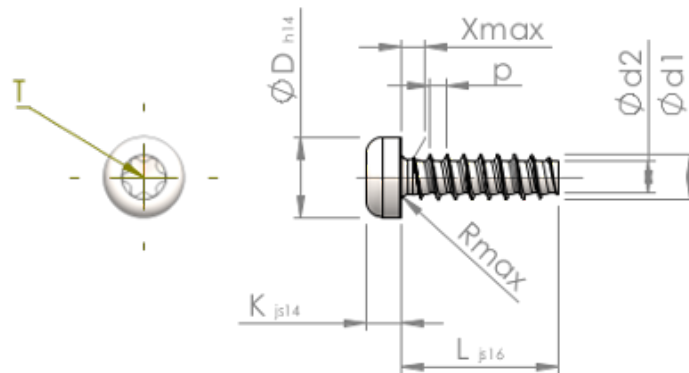

Item Number		STP390300120E
Standard		KN6039
Material		stainless-steel A2
Surface		bright, pickled and passivated
Thread Outside-Ø	d1	3.00 ^{+0.10} mm
Thread Core-Ø	d2	2.09 mm
Thread Pitch	p	1.12 mm
Length	L	12.00 ±0.55 mm
Head-Ø	D	5.30 _{-0.30} mm
Head Height	K	2.300 ±0.125 mm
Thread Run-Out	X	1.50 mm
Radius	R	0.50 mm
Size Six Lobe		T10
Penetration Depth	t	1.00 - 1.30 mm
Thread		STS-plus
Weight		0.691 kg / 1000 pieces
Customs Tariff No		73 181 410