

Technische gegevens
STP390300080E

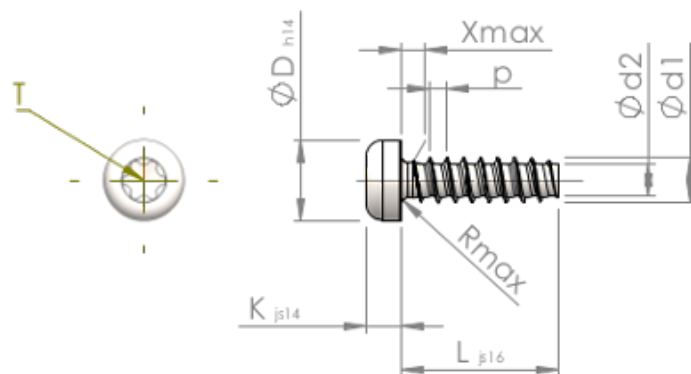

Produktnummer		STP390300080E
Norm		KN6039
Materiaal		roestvrij staal A2
Oppervlak		blank, geetst en gepassiveerd
Schroefdraad buiten- \varnothing	d1	3.00 ^{+0.10} mm
Schroefdraad kern- \varnothing	d2	2.09 mm
Spoed	p	1.12 mm
Lengte	L	8.00 \pm 0.45 mm
Kop- \varnothing	D	5.30 _{-0.30} mm
Kop hoogte	K	2.300 \pm 0.125 mm
Draaduitloop	X	1.50 mm
Radius	R	0.50 mm
TX		T10
Indringdiepte	t	1.00 - 1.30 mm
Draad		STS-plus
Gewicht		0.555 kg / 1000 stuk
Douane tarief nummer		73 181 410