

Technische gegevens
STP390250130C

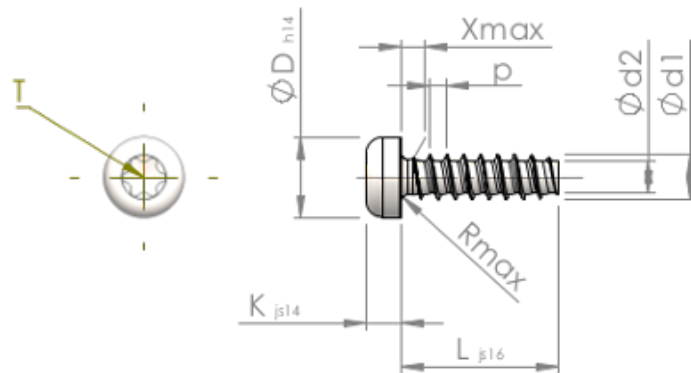

Produktnummer		STP390250130C
Norm		KN6039
Materiaal		roestvrij staal A4
Oppervlak		blank, geetst en gepassiveerd
Schroefdraad buiten- \varnothing	d1	2.50 ^{+0.10} mm
Schroefdraad kern- \varnothing	d2	1.72 mm
Spoed	p	0.95 mm
Lengte	L	13.00 \pm 0.55 mm
Kop- \varnothing	D	4.40 _{-0.30} mm
Kop hoogte	K	1.900 \pm 0.125 mm
Draaduitloop	X	1.30 mm
Radius	R	0.40 mm
TX		T8
Indringdiepte	t	0.80 - 1.00 mm
Draad		STS-plus
Gewicht		0.474 kg / 1000 stuk
Douane tarief nummer		73 181 410