

Technische gegevens
STP390250110B

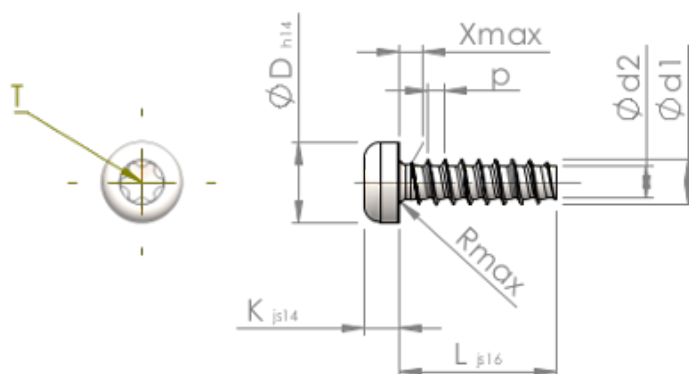

Produktnummer		STP390250110B
Norm		KN6039
Materiaal		veredeld staal
Oppervlak		ZnNi zwart-gepassiveerd, getempert, verzegeld
Schroefdraad buiten-Ø	d1	2.50 ^{+0.10} mm
Schroefdraad kern-Ø	d2	1.72 mm
Spoed	p	0.95 mm
Lengte	L	11.00 ±0.55 mm
Kop-Ø	D	4.40 _{-0.30} mm
Kop hoogte	K	1.900 ±0.125 mm
Draaduitloop	X	1.30 mm
Radius	R	0.40 mm
TX		T8
Indringdiepte	t	0.80 - 1.00 mm
Draad		STS-plus
Gewicht		0.426 kg / 1000 stuk
Douane tarief nummer		73 181 499