

Technische gegevens
STP390220200E

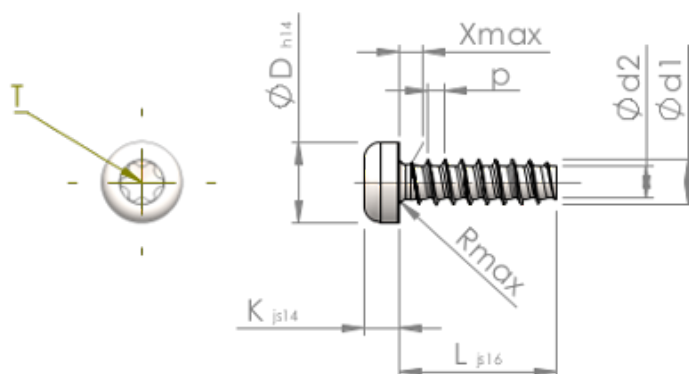

Produktnummer		STP390220200E
Norm		KN6039
Materiaal		roestvrij staal A2
Oppervlak		blank, geetst en gepassiveerd
Schroefdraad buiten- \varnothing	d1	2.20 ^{+0.08} mm
Schroefdraad kern- \varnothing	d2	1.51 mm
Spoed	p	0.85 mm
Lengte	L	20.00 \pm 0.65 mm
Kop- \varnothing	D	3.90 _{-0.30} mm
Kop hoogte	K	1.600 \pm 0.125 mm
Draaduitloop	X	1.10 mm
Radius	R	0.35 mm
TX		T6
Indringdiepte	t	0.65 - 0.85 mm
Draad		STS-plus
Gewicht		0.476 kg / 1000 stuk
Douane tarief nummer		73 181 410