

Technische gegevens
STP390220045S

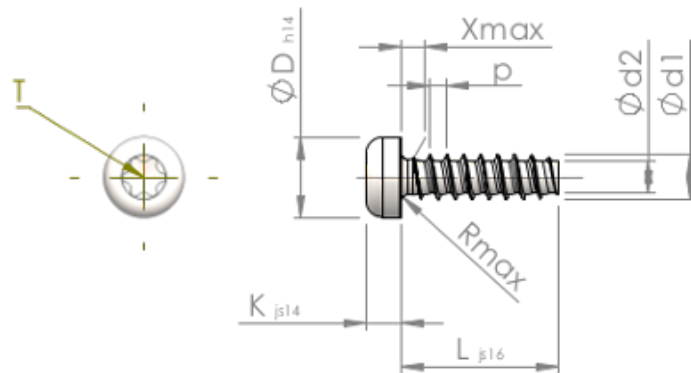

Produktnummer		STP390220045S
Norm		KN6039
Materiaal		veredeld staal
Oppervlak		verzinkt 5-7 μm , getempert, blauw / transparant gepassiveerd
Schroefdraad buiten- \varnothing	d1	2.20 $^{+0.08}$ mm
Schroefdraad kern- \varnothing	d2	1.51 mm
Spoed	p	0.85 mm
Lengte	L	4.50 ± 0.38 mm
Kop- \varnothing	D	3.90 $_{-0.30}$ mm
Kop hoogte	K	1.600 ± 0.125 mm
Draaduitloop	X	1.10 mm
Radius	R	0.35 mm
TX		T6
Indringdiepte	t	0.65 - 0.85 mm
Draad		STS-plus
Gewicht		0.189 kg / 1000 stuk
Douane tarief nummer		73 181 499