

Technische gegevens
STP390200130E

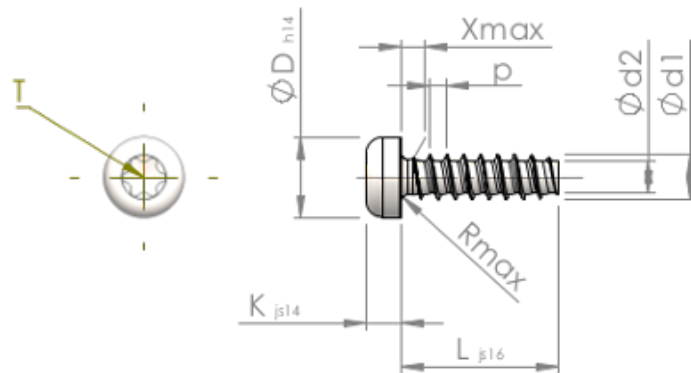

Produktnummer		STP390200130E
Norm		KN6039
Materiaal		roestvrij staal A2
Oppervlak		blank, geetst en gepassiveerd
Schroefdraad buiten- \varnothing	d1	2.00 ^{+0.08} mm
Schroefdraad kern- \varnothing	d2	1.36 mm
Spoed	p	0.78 mm
Lengte	L	13.00 \pm 0.55 mm
Kop- \varnothing	D	3.50 _{-0.30} mm
Kop hoogte	K	1.600 \pm 0.125 mm
Draaduitloop	X	1.00 mm
Radius	R	0.35 mm
TX		T6
Indringdiepte	t	0.65 - 0.85 mm
Draad		STS-plus
Gewicht		0.284 kg / 1000 stuk
Douane tarief nummer		73 181 410