

Spec Sheet STP390200070E

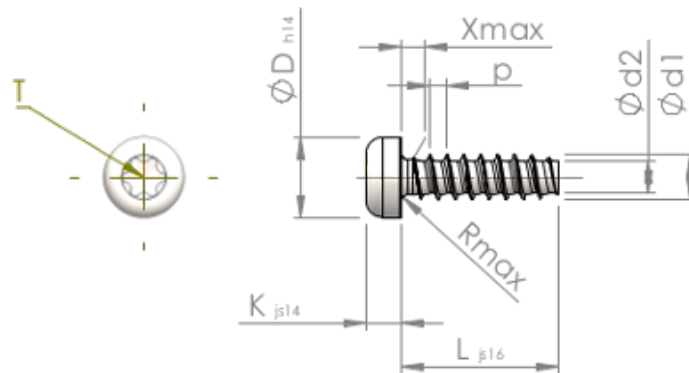

Item Number		STP390200070E
Standard		KN6039
Material		stainless-steel A2
Surface		bright, pickled and passivated
Thread Outside-Ø	d1	2.00 ^{+0.08} mm
Thread Core-Ø	d2	1.36 mm
Thread Pitch	p	0.78 mm
Length	L	7.00 ±0.45 mm
Head-Ø	D	3.50 _{-0.30} mm
Head Height	K	1.600 ±0.125 mm
Thread Run-Out	X	1.00 mm
Radius	R	0.35 mm
Size Six Lobe		T6
Penetration Depth	t	0.65 - 0.85 mm
Thread		STS-plus
Weight		0.191 kg / 1000 pieces
Customs Tariff No		73 181 410