

Technische gegevens
STP390200040B

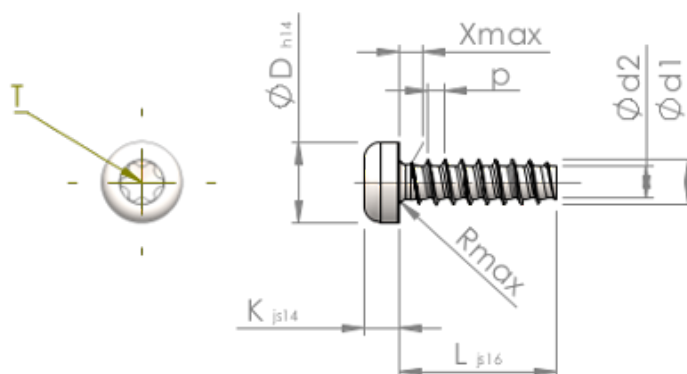

Produktnummer		STP390200040B
Norm		KN6039
Materiaal		veredeld staal
Oppervlak		ZnNi zwart-gepassiveerd, getempert, verzegeld
Schroefdraad buiten-Ø	d1	2.00 ^{+0.08} mm
Schroefdraad kern-Ø	d2	1.36 mm
Spoed	p	0.78 mm
Lengte	L	4.00 ±0.38 mm
Kop-Ø	D	3.50 _{-0.30} mm
Kop hoogte	K	1.600 ±0.125 mm
Draaduitloop	X	1.00 mm
Radius	R	0.35 mm
TX		T6
Indringdiepte	t	0.65 - 0.85 mm
Draad		STS-plus
Gewicht		0.144 kg / 1000 stuk
Douane tarief nummer		73 181 499