

Technische gegevens
STP390180200B

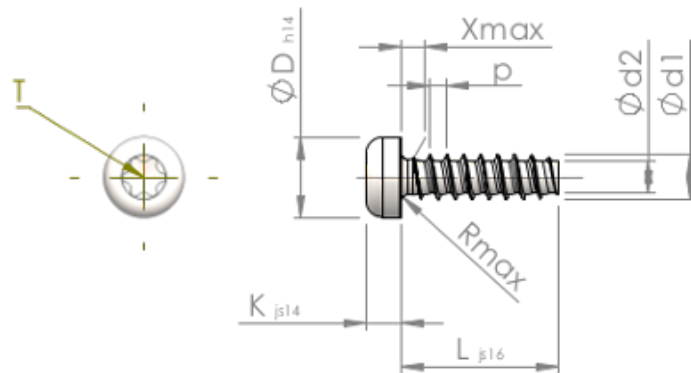

Produktnummer		STP390180200B
Norm		KN6039
Materiaal		veredeld staal
Oppervlak		ZnNi zwart-gepassiveerd, getempert, verzegeld
Schroefdraad buiten-Ø	d1	1.80 ^{+0.08} mm
Schroefdraad kern-Ø	d2	1.22 mm
Spoed	p	0.71 mm
Lengte	L	20.00 ±0.65 mm
Kop-Ø	D	3.30 _{-0.30} mm
Kop hoogte	K	1.300 ±0.125 mm
Draaduitloop	X	0.90 mm
Radius	R	0.25 mm
TX		T6
Indringdiepte	t	0.50 - 0.65 mm
Draad		STS-plus
Gewicht		0.312 kg / 1000 stuk
Douane tarief nummer		73 181 499