

Spec Sheet STP390180200B

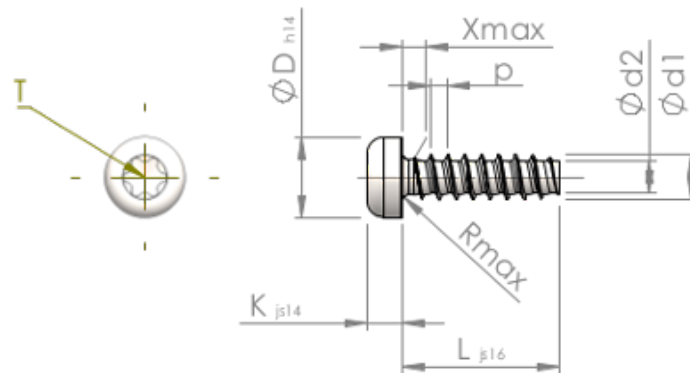

Item Number		STP390180200B
Standard		KN6039
Material		steel, hardened
Surface		Zinc-Nickel-plated min. 5µm, passivated black/ Cr-VI-free, baked, sealed
Thread Outside-Ø	d1	1.80 ^{+0.08} mm
Thread Core-Ø	d2	1.22 mm
Thread Pitch	p	0.71 mm
Length	L	20.00 ±0.65 mm
Head-Ø	D	3.30 _{-0.30} mm
Head Height	K	1.300 ±0.125 mm
Thread Run-Out	X	0.90 mm
Radius	R	0.25 mm
Size Six Lobe		T6
Penetration Depth	t	0.50 - 0.65 mm
Thread		STS-plus
Weight		0.312 kg / 1000 pieces
Customs Tariff No		73 181 499