

**Technische gegevens**  
**STP390180040B**

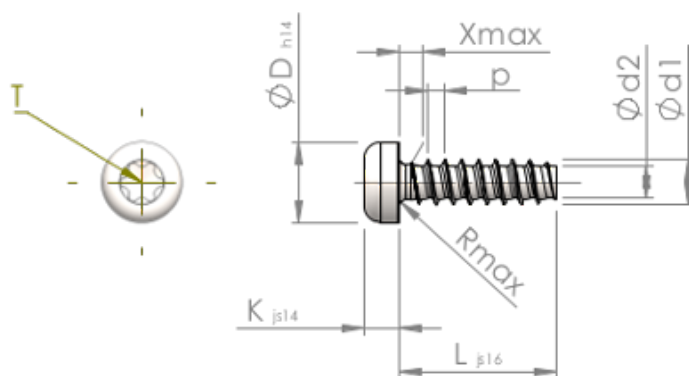

Produktnummer		STP390180040B
Norm		KN6039
Materiaal		veredeld staal
Oppervlak		ZnNi zwart-gepassiveerd, getempert, verzegeld
Schroefdraad buiten-Ø	<b>d1</b>	1.80 <sup>+0.08</sup> mm
Schroefdraad kern-Ø	<b>d2</b>	1.22 mm
Spoed	<b>p</b>	0.71 mm
Lengte	<b>L</b>	4.00 ±0.38 mm
Kop-Ø	<b>D</b>	3.30 <sub>-0.30</sub> mm
Kop hoogte	<b>K</b>	1.300 ±0.125 mm
Draaduitloop	<b>X</b>	0.90 mm
Radius	<b>R</b>	0.25 mm
TX		T6
Indringdiepte	<b>t</b>	0.50 - 0.65 mm
Draad		STS-plus
Gewicht		0.113 kg / 1000 stuk
Douane tarief nummer		73 181 499