

**Technische gegevens**  
**STP390160120B**

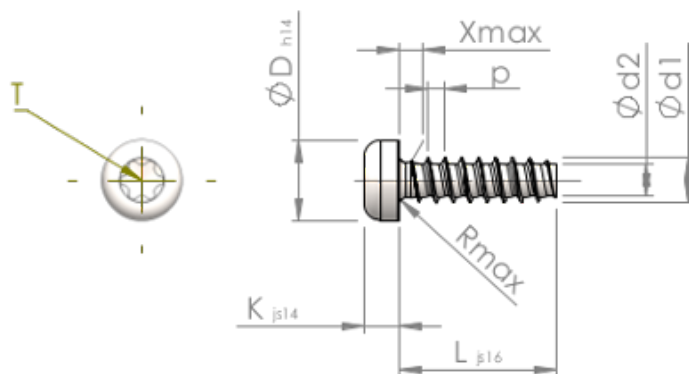

Produktnummer		STP390160120B
Norm		KN6039
Materiaal		veredeld staal
Oppervlak		ZnNi zwart-gepassiveerd, getempert, verzegeld
Schroefdraad buiten-Ø	<b>d1</b>	1.60 <sup>+0.08</sup> mm
Schroefdraad kern-Ø	<b>d2</b>	1.07 mm
Spoed	<b>p</b>	0.64 mm
Lengte	<b>L</b>	12.00 ±0.55 mm
Kop-Ø	<b>D</b>	3.00 <sub>-0.25</sub> mm
Kop hoogte	<b>K</b>	1.200 ±0.125 mm
Draaduitloop	<b>X</b>	0.80 mm
Radius	<b>R</b>	0.20 mm
TX		T5
Indringdiepte	<b>t</b>	0.50 - 0.65 mm
Draad		STS-plus
Gewicht		0.164 kg / 1000 stuk
Douane tarief nummer		73 181 499