

Technische gegevens
STP390140120E

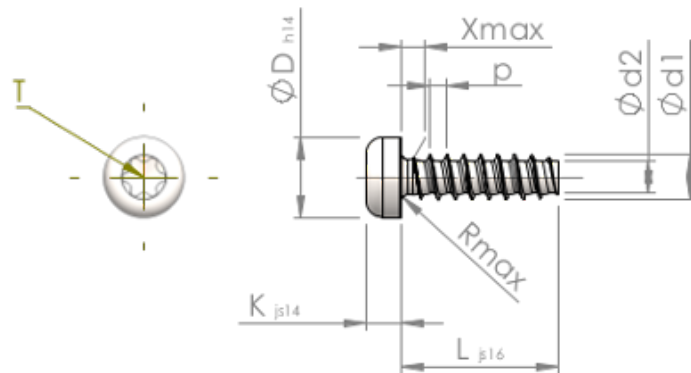

Produktnummer		STP390140120E
Norm		KN6039
Materiaal		roestvrij staal A2
Oppervlak		blank, geetst en gepassiveerd
Schroefdraad buiten-Ø	d1	1.40 ^{+0.08} mm
Schroefdraad kern-Ø	d2	0.93 mm
Spoed	p	0.57 mm
Lengte	L	12.00 ±0.55 mm
Kop-Ø	D	2.60 _{-0.25} mm
Kop hoogte	K	1.050 ±0.125 mm
Draaduitloop	X	0.70 mm
Radius	R	0.20 mm
TX		T3
Indringdiepte	t	0.35 - 0.50 mm
Draad		STS-plus
Gewicht		0.121 kg / 1000 stuk
Douane tarief nummer		73 181 410