

Spec Sheet STP390140090E

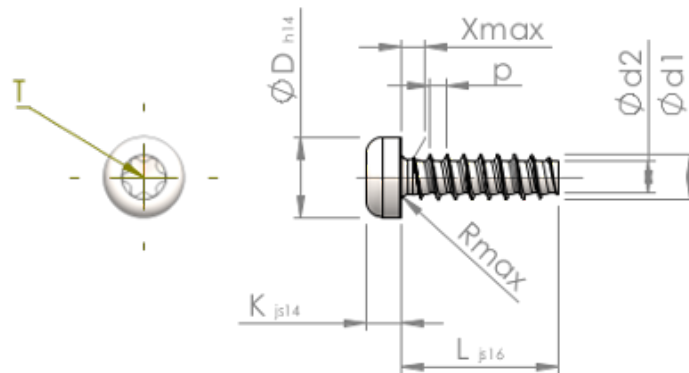

Item Number		STP390140090E
Standard		KN6039
Material		stainless-steel A2
Surface		bright, pickled and passivated
Thread Outside-Ø	d1	1.40 ^{+0.08} mm
Thread Core-Ø	d2	0.93 mm
Thread Pitch	p	0.57 mm
Length	L	9.00 ±0.45 mm
Head-Ø	D	2.60 _{-0.25} mm
Head Height	K	1.050 ±0.125 mm
Thread Run-Out	X	0.70 mm
Radius	R	0.20 mm
Size Six Lobe		T3
Penetration Depth	t	0.35 - 0.50 mm
Thread		STS-plus
Weight		0.099 kg / 1000 pieces
Customs Tariff No		73 181 410