

Technische gegevens
STP390100045B

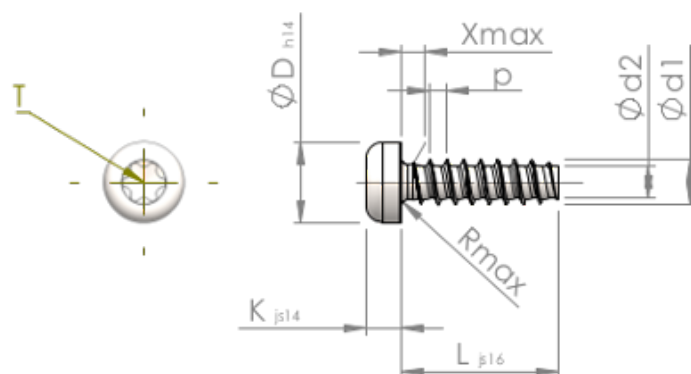

Produktnummer		STP390100045B
Norm		KN6039
Materiaal		veredeld staal
Oppervlak		ZnNi zwart-gepassiveerd, getempert, verzegeld
Schroefdraad buiten-Ø	d1	1.00 ^{+0.08} mm
Schroefdraad kern-Ø	d2	0.64 mm
Spoed	p	0.44 mm
Lengte	L	4.50 ±0.38 mm
Kop-Ø	D	2.00 _{-0.25} mm
Kop hoogte	K	0.800 ±0.125 mm
Draaduitloop	X	0.50 mm
Radius	R	0.20 mm
TX		T3
Indringdiepte	t	0.30 - 0.45 mm
Draad		STS-plus
Gewicht		0.030 kg / 1000 stuk
Douane tarief nummer		73 181 499