

**Technische gegevens**  
**STP380800800S**

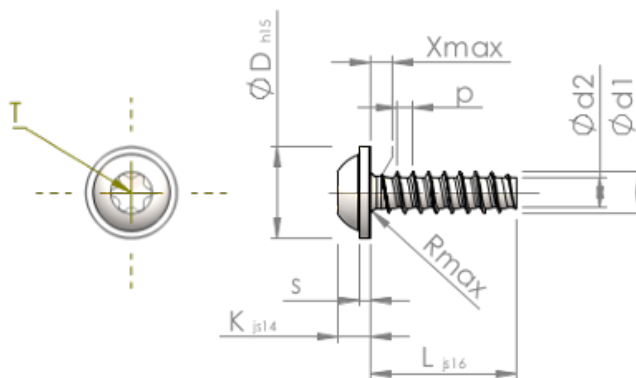

Produktnummer		STP380800800S
Norm		KN6038
Materiaal		veredeld staal
Oppervlak		verzinkt 5-7 µm, getempert, blauw / transparant gepassiveerd
Schroefdraad buiten-Ø	<b>d1</b>	8.00 <sup>+0.18</sup> mm
Schroefdraad kern-Ø	<b>d2</b>	5.70 mm
Spoed	<b>p</b>	2.82 mm
Lengte	<b>L</b>	80.00 ±0.95 mm
Kop-Ø	<b>D</b>	18.00 <sub>-0.84</sub> mm
Kop hoogte	<b>K</b>	5.600 ±0.150 mm
Flensdikte	<b>S</b>	1.80 mm
Draaduitloop	<b>X</b>	4.00 mm
Radius	<b>R</b>	1.00 mm
TX		T40
Indringdiepte	<b>t</b>	2.60 - 3.20 mm
Draad		STS-plus
Gewicht		24.637 kg / 1000 stuk
Douane tarief nummer		73 181 499