

Technische gegevens
STP380800650E

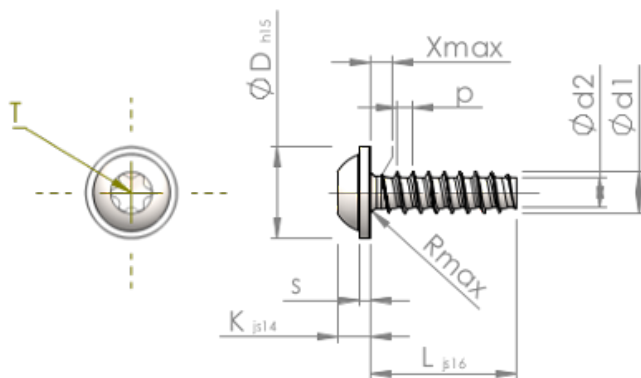

Produktnummer		STP380800650E
Norm		KN6038
Materiaal		roestvrij staal A2
Oppervlak		blank, geetst en gepassiveerd
Schroefdraad buiten-Ø	d1	8.00 ^{+0.18} mm
Schroefdraad kern-Ø	d2	5.70 mm
Spoed	p	2.82 mm
Lengte	L	65.00 ±0.95 mm
Kop-Ø	D	18.00 _{-0.84} mm
Kop hoogte	K	5.600 ±0.150 mm
Flensdikte	S	1.80 mm
Draaduitloop	X	4.00 mm
Radius	R	1.00 mm
TX		T40
Indringdiepte	t	2.60 - 3.20 mm
Draad		STS-plus
Gewicht		21.024 kg / 1000 stuk
Douane tarief nummer		73 181 410