

Spec Sheet STP380800350B

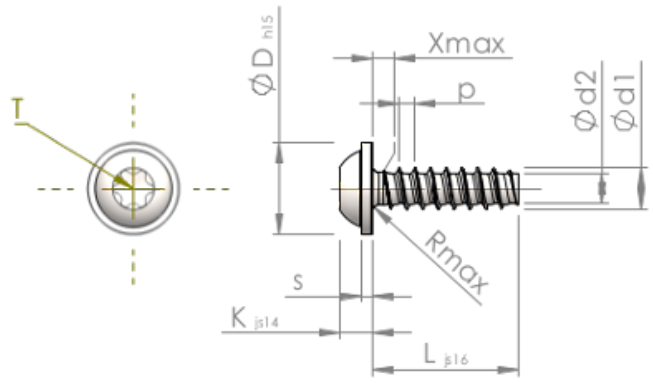

Item Number		STP380800350B
Standard		KN6038
Material		steel, hardened
Surface		Zinc-Nickel-plated min. 5µm, passivated black/ Cr-VI-free, baked, sealed
Thread Outside-Ø	d1	8.00 ^{+0.18} mm
Thread Core-Ø	d2	5.70 mm
Thread Pitch	p	2.82 mm
Length	L	35.00 ±0.80 mm
Head-Ø	D	18.00 _{-0.84} mm
Head Height	K	5.600 ±0.150 mm
Flange Thickness	S	1.80 mm
Thread Run-Out	X	4.00 mm
Radius	R	1.00 mm
Size Six Lobe		T40
Penetration Depth	t	2.60 - 3.20 mm
Thread		STS-plus
Weight		13.799 kg / 1000 pieces
Customs Tariff No		73 181 499