

Technische gegevens
STP380600450S

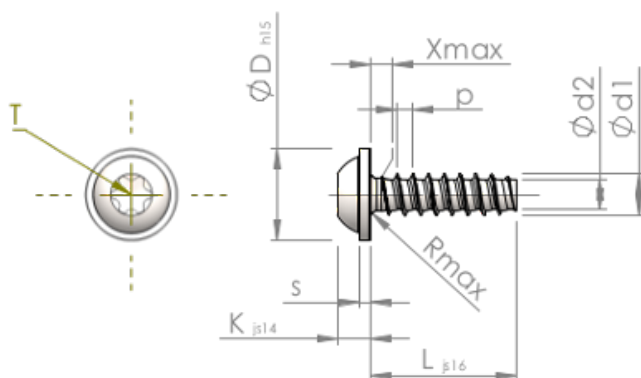

Produktnummer		STP380600450S
Norm		KN6038
Materiaal		veredeld staal
Oppervlak		verzinkt 5-7 µm, getempert, blauw / transparant gepassiveerd
Schroefdraad buiten-Ø	d1	6.00 ^{+0.15} mm
Schroefdraad kern-Ø	d2	4.26 mm
Spoed	p	2.14 mm
Lengte	L	45.00 ±0.80 mm
Kop-Ø	D	13.50 _{-0.70} mm
Kop hoogte	K	4.200 ±0.150 mm
Flensdikte	S	1.40 mm
Draaduitloop	X	3.00 mm
Radius	R	0.80 mm
TX		T30
Indringdiepte	t	1.90 - 2.40 mm
Draad		STS-plus
Gewicht		8.500 kg / 1000 stuk
Douane tarief nummer		73 181 499