

**Technische gegevens**  
**STP380600180S**

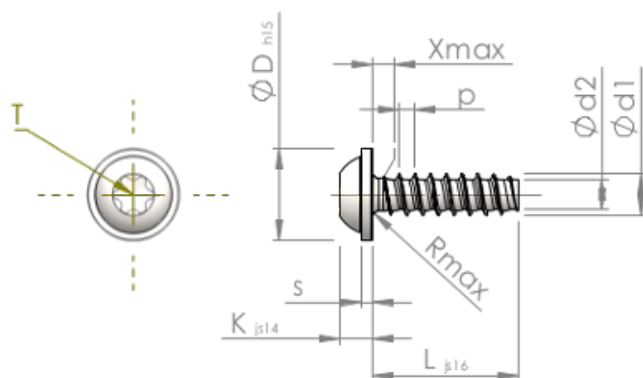

Produktnummer		STP380600180S
Norm		KN6038
Materiaal		veredeld staal
Oppervlak		verzinkt 5-7 $\mu\text{m}$ , getempert, blauw / transparant gepassiveerd
Schroefdraad buiten- $\varnothing$	<b>d1</b>	6.00 $^{+0.15}$ mm
Schroefdraad kern- $\varnothing$	<b>d2</b>	4.26 mm
Spoed	<b>p</b>	2.14 mm
Lengte	<b>L</b>	18.00 $\pm 0.55$ mm
Kop- $\varnothing$	<b>D</b>	13.50 $_{-0.70}$ mm
Kop hoogte	<b>K</b>	4.200 $\pm 0.150$ mm
Flensdikte	<b>S</b>	1.40 mm
Draaduitloop	<b>X</b>	3.00 mm
Radius	<b>R</b>	0.80 mm
TX		T30
Indringdiepte	<b>t</b>	1.90 - 2.40 mm
Draad		STS-plus
Gewicht		4.838 kg / 1000 stuk
Douane tarief nummer		73 181 499