

Spec Sheet STP380600140S

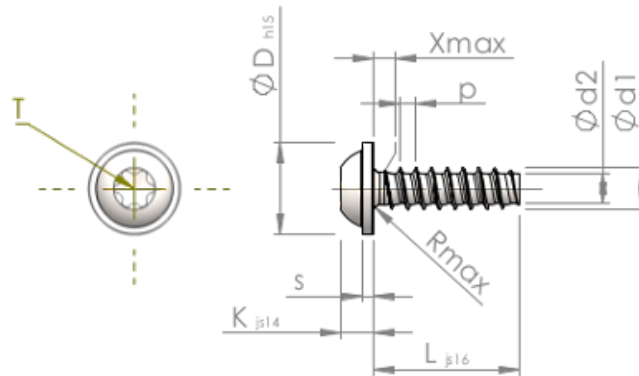

Item Number		STP380600140S
Standard		KN6038
Material		steel, hardened
Surface		zinc-plated 5-7 µm, baked, blue / transparent passivated
Thread Outside-Ø	<b>d1</b>	6.00 <sup>+0.15</sup> mm
Thread Core-Ø	<b>d2</b>	4.26 mm
Thread Pitch	<b>p</b>	2.14 mm
Length	<b>L</b>	14.00 ±0.55 mm
Head-Ø	<b>D</b>	13.50 <sub>-0.70</sub> mm
Head Height	<b>K</b>	4.200 ±0.150 mm
Flange Thickness	<b>S</b>	1.40 mm
Thread Run-Out	<b>X</b>	3.00 mm
Radius	<b>R</b>	0.80 mm
Size Six Lobe		T30
Penetration Depth	<b>t</b>	1.90 - 2.40 mm
Thread		STS-plus
Weight		4.295 kg / 1000 pieces
Customs Tariff No		73 181 499